

KLEM A1 LED zoombarer Schienenstrahler

KLEM A1, C135 (INT) Zoombar 19°-60°

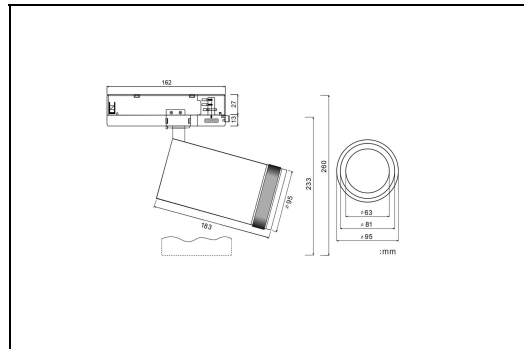

CITIZEN
LED Chip

OSRAM
LED Treiber

keine Dimmoption
Dimm-Optionen

Aluminium
Gehäuse und Befestigung

weiß schwarz
Farben



Produkt Beschreibung

LED Schienenstrahler 35W
Hoher CRI, 2700K/3000K/3500K/4000K Ra>90, 5000K Ra>80, zoombare Linsen, Abstrahlwinkel 19~60 Grad
Innenanwendung

Technische Daten

Artikelnummer:	KLEM A1, C135(INT)
Watt:	35W
Volt:	220~240V~50/60Hz
Leistungsfaktor:	>0.92
Abstrahlwinkel:	Zoombar 19°~60°
Lumen:	3000lm (±200)
Farbtemperatur:	2700K/3000K/3500K/4000K/5000K C
Farbwiedergabeindex:	Ri ≥90, 5000K CRI ≥80
Anschlüsse:	4-Kabel 3-Phasen
Dimm-Optionen:	Keine Dimmoptionen
Gewicht:	1.75kg
Material:	Aluminium
Farbe:	sandy weiß oder schwarz
Arbeitstemperatur:	(-20~40 °C)
Aufbewahrungstemperatur:	(-20~80 °C)
Lebensdauer:	50000 Std.
zertifikate:	CE-EMC, CE-LVD, TUV, SAA, CB
garantie:	5 Jahre
Testberichte:	IES file/ spectrum chart

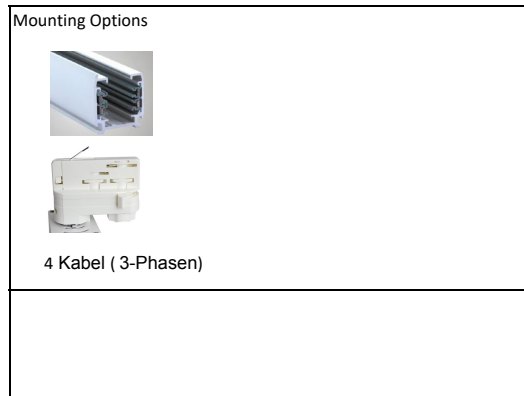

Verpackung 8 Stck. 14KG/KTN 54.5*26.6*48.2cm

*Alle technischen Daten unterliegen industriellen Messstandards und Toleranzen.

Spectrum Test Report

2700K

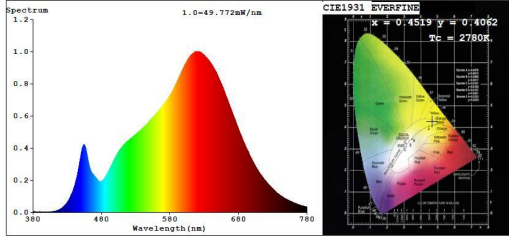

Color Parameters:
 Chromaticity Coordinate: $x=0.4519$ $y=0.4062/u'=0.2593$ $v'=0.5245$
 $Tc=2780K$ (Duv=-0.0009) Dominant WL:Ld =584.1nm Purity=57.6%
 Red Ratio:R=27.8% Peak WL:Lp=618.0nm HWL:Lhd=147.6nm
 Render Index:Ra=94.1
 R1 =95 R2 =98 R3 =99 R4 =95 R5 =95 R6 =97 R7 =91
 R8 =82 R9 =62 R10=95 R11=97 R12=87 R13=96 R14=99 R15=90

Photo Parameters:
 Flux = 2300 lm Eff. : 81.01 lm/W Fe = 8.137 W

3000K

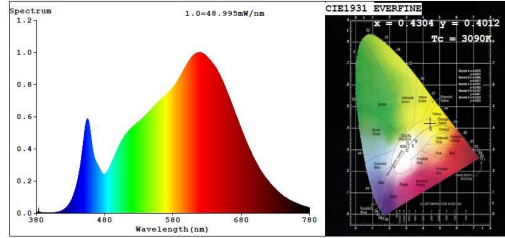

Color Parameters:
 Chromaticity Coordinate: $x=0.4304$ $y=0.4012/u'=0.2476$ $v'=0.5193$
 $Tc=3090K$ (Duv=-0.0002) Dominant WL:Ld =582.5nm Purity=49.6%
 Red Ratio:R=25.6% Peak WL:Lp=619.5nm HWL:Lhd=169.1nm
 Render Index:Ra=94.3
 R1 =95 R2 =97 R3 =99 R4 =95 R5 =95 R6 =96 R7 =93
 R8 =85 R9 =66 R10=93 R11=96 R12=81 R13=96 R14=99 R15=91

Photo Parameters:
 Flux = 2477 lm Eff. : 85.92 lm/W Fe = 8.635 W

3500K

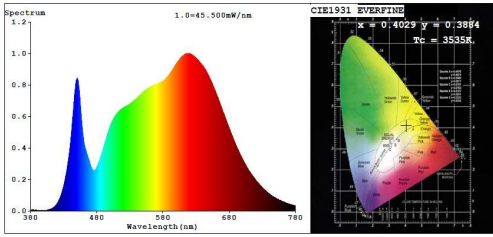

Color Parameters:
 Chromaticity Coordinate: $x=0.4029$ $y=0.3884/u'=0.2351$ $v'=0.5100$
 $Tc=3535K$ (Duv=-0.0005) Dominant WL:Ld =581.0nm Purity=37.5%
 Red Ratio:R=23.3% Peak WL:Lp=619.8nm HWL:Lhd=185.3nm
 Render Index:Ra=94.8
 R1 =96 R2 =96 R3 =96 R4 =96 R5 =95 R6 =95 R7 =95
 R8 =89 R9 =73 R10=91 R11=96 R12=82 R13=96 R14=97 R15=93

Photo Parameters:
 Flux = 2532 lm Eff. : 86.71 lm/W Fe = 8.810 W

4000K

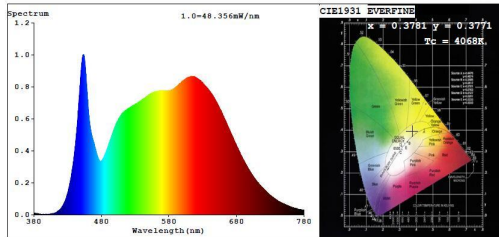

Color Parameters:
 Chromaticity Coordinate: $x=0.3781$ $y=0.3771/u'=0.2234$ $v'=0.5014$
 $Tc=4068K$ (Duv=0.0008) Dominant WL:Ld =578.3nm Purity=26.6%
 Red Ratio:R=21.1% Peak WL:Lp=453.7nm HWL:Lhd=23.0nm
 Render Index:Ra=94.1
 R1 =95 R2 =96 R3 =96 R4 =95 R5 =94 R6 =93 R7 =96
 R8 =89 R9 =71 R10=90 R11=95 R12=73 R13=96 R14=98 R15=92

Photo Parameters:
 Flux = 2579 lm Eff. : 88.72 lm/W Fe = 8.857 W

5000K

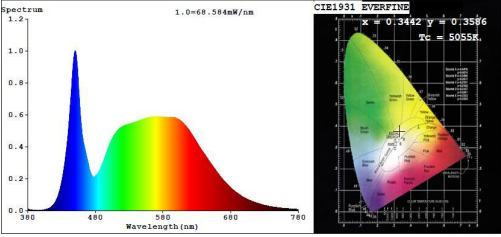

Color Parameters:
 Chromaticity Coordinate: $x=0.3442$ $y=0.3586/u'=0.2092$ $v'=0.4879$
 $Tc=5055K$ (Duv=0.0038) Dominant WL:Ld =568.5nm Purity=10.9%
 Red Ratio:R=17.0% Peak WL:Lp=450.0nm HWL:Lhd=20.0nm
 Render Index:Ra=83.9
 R1 =82 R2 =87 R3 =92 R4 =85 R5 =83 R6 =83 R7 =88
 R8 =70 R9 =14 R10=71 R11=85 R12=64 R13=83 R14=95 R15=77

Photo Parameters:
 Flux = 2651 lm Eff. : 90.73 lm/W Fe = 8.314 W